

Artikel Nr.: 620017

Möbelaufbauleuchte, Spiegel Rund, 5er Bundle



**Lieferumfang**

Artikel Nr.	Bezeichnung	Anschlußmöglichkeit	Menge
687130	Möbelaufbauleuchte, Spiegel Rund, silberfarben, 12V DC, 4,50 W, Neutralweiß	1,5 m Anschlußkabel mit Mini AMP Stecker	5
862169	Netzgerät, DIM, CV, 12V 2,5-25W	1,9 m Anschlußkabel mit Netzstecker - primär 1,8 m Anschlußkabel mit 6er Mini AMP Verteiler - sekundär	1

Artikel No.: 620017

Surface mounted furniture lamp, Mirror Round 5 Pack Bundle



**Scope of Delivery**

Artikel No.	Description	Connectivity	Quantity
687130	Surface mounted furniture lamp, Mirror Round, silver, 12V DC, 4,50 W, neutral white	1,5 m connection cable with mini AMP plug	5
862169	Netzgerät, DIM, CV, 12V 2,5-25W	1,9 m connection cable with Power plug - primary 1,8 m connection cable with sixfold mini AMP distributor - secondary	1

**Artikel Nr.: 687130**

Möbelaufbauleuchte, Spiegel Rund, silberfarben, 12V DC, 4,50 W, Neutralweiß

**Technische Daten**

**Charakteristik**



<b>Material</b>	Aluminium
<b>Farbe</b>	silberfarben
<b>Optik</b>	Chrom
<b>im Lieferumfang</b>	Schrauben 1,5 m Anschlußkabel mit Mini AMP Stecker

**Elektrische Daten**

<b>Leistung / Leistungsaufnahme</b>	4,50 W / 4,50 W
<b>Eingangsspannung</b>	12V DC
<b>Eingangsstrom</b>	
<b>Fassung / Sockel</b>	
<b>Anzahl Sockel</b>	
<b>Netzgerät</b>	exkl. LED-Netzgerät
<b>Ansteuerung</b>	nicht dimmbar
<b>Anschlussmöglichkeit</b>	Mini AMP Stecker
<b>Schutzklasse I, II, III</b>	III

**Lichttechnische Eigenschaften**

<b>Leuchtmittel</b>	LED-Modul fest
<b>Lichtfarbe</b>	Neutralweiß
<b>Farbtemperatur</b>	4000 K
<b>Lichtstrom</b>	300 lm
<b>Abstrahlwinkel</b>	120°
<b>LED Typ</b>	SMD
<b>LED Anzahl</b>	24
<b>Strahlungsverteilung</b>	578 nm



**Artikel Nr.: 687130**

Möbelaufbauleuchte, Spiegel Rund, silberfarben, 12V DC, 4,50 W, Neutralweiß

**Lichtrichtung**

Dreh- und Schwenkbereich	feststehend
Neigungswinkel	
Abstrahlverhalten	
Reflektor / Linse	

**Abmessungen und Gewicht**

Länge	96,5 mm
Breite	
Höhe	14 mm
Durchmesser	80 mm
Einbautiefe	
Gewicht	92 g

**Ausschnittsmaß**

Länge	
Breite	
Durchmesser	

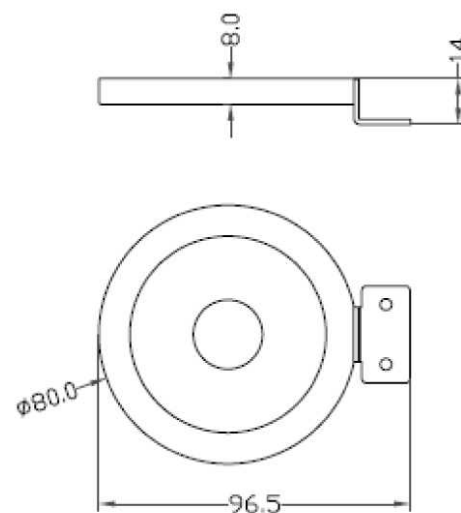

**Artikel Nr.: 687130**

Möbelaufbauleuchte, Spiegel Rund, silberfarben, 12V DC, 4,50 W, Neutralweiß

**Grenzwerte**

Die Überschreitung der Grenzwerte und Betriebsspannung führt zu einer starken Verkürzung der Lebensdauer sowie Zerstörung der LED Module.

Betriebstemperatur	-5°C - +40°C
Lagertemperatur	-10°C - +40°C
IP - Schutzart	IP44



**Allgemeine Eigenschaften**

**Umwelteigenschaften**

Energieeffizienzklasse	A+
Energieverbrauch	5 kWh/1000h

**Lebensdauer**

Lebensdauer	30000 h
Lichtstrom Ende Lebensdauer	0,70
Schaltzyklen	20000

IP44	Schutz gegen das Eindringen von Fremdkörper > 1 mm. Geschützt gegen Spritzwasser.
	Leuchte der Schutzklasse III Leuchte, bei der der Schutz gegen elektrischen Schlag auf der Anwendung der Schutzkleinspannung (SELV) beruht und in der Spannungen höher als SELV nicht erzeugt werden.
	Aufgrund des komplexen Herstellungsprozesses von LED stellen die angegebenen Werte nur rein statistische Größen dar und müssen nicht zwingend den tatsächlichen Parametern jedes einzelnen LED-Moduls entsprechen, sondern können von den typischen Werten abweichen.
	Die Lichtquelle dieser Leuchte darf nur vom Hersteller oder einem von ihm beauftragten Servicetechniker oder einer vergleichbar qualifizierten Person ersetzt werden

**Article no.: 687130**

Surface mounted furniture lamp, Mirror Round, silver, 12V DC, 4,50 W, neutral white

**Technical Data****General Characteristics**

<b>Material</b>	aluminum
<b>Colour</b>	silver
<b>Optics</b>	chrome
<b>included in delivery</b>	screws 1,5 m connection cable with mini AMP plug

**Electrical Characteristics**

<b>Power / power consumption</b>	4,50 W / 4,50 W
<b>input voltage</b>	12V DC
<b>input current</b>	
<b>Base (standard designation)</b>	
<b>Number of bases</b>	
<b>Power supply unit</b>	excl. LED-power supply unit
<b>Electronically reversible</b>	not dimmable
<b>Connection possibility</b>	Mini AMP plug
<b>Protection class I, II, III</b>	III

**Light Technical Data**

<b>Bulb</b>	LED-module fixed
<b>Colour Designation</b>	neutral white
<b>Colour temperature</b>	4000 K
<b>Luminous flux</b>	300 lm
<b>Beam angle</b>	120°
<b>LED type</b>	SMD
<b>LED quantity</b>	24
<b>Spectral power distribution</b>	578 nm



**Article no.: 687130**

Surface mounted furniture lamp, Mirror Round, silver, 12V DC, 4,50 W, neutral white

**Light Direction**

Rotating and tilting range	fixed
Angle of inclination	
Radiation direction	
Reflector / lense	

**Dimensions & Weight**

Length	96,5 mm
Width	
Height	14 mm
Diameter	80 mm
Mounting Depth	
Product Weight	92 g

**Cut-out dimensions**

Length	
Width	
Diameter	

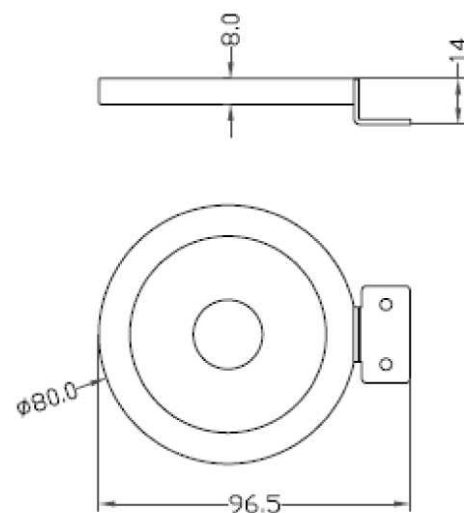

## Article no.: 687130

Surface mounted furniture lamp, Mirror Round, silver, 12V DC, 4,50 W, neutral white

### Absolute maximum ratings

The LED will get damaged and the lifetime will decrease when you overrun absolute maximum ratings.

Working temperature	-5°C - +40°C
Storage temperature	-10°C - +40°C
IP - Code	IP44



### General product data

#### Environmental Characteristics

Energy label	A+
Energy consumption	5 kWh/1000h

#### Lifespan

Lamp life time	30000 h
Luminous flux (end of lifetime)	0,70
Number of switching cycles	20000

IP44	Protection against penetration of foreign objects > 1 mm. Protection against penetration of splashing water.
	Lightings of Protection Class III Luminaire in which protection against electric shock relies on supply at safety extra-low voltage (SELV) and in which voltages higher than those of SELV are not generated.
	Because of the complex manufacturing process of the LED the above shown data are just a statistical size, which is not forced to be the realistic data of every LED.
	The light source of this luminaire may only be replaced by the manufacturer or by a service technician appointed by him or by a comparable qualified person



**Artikel Nr.: 862169**

Netzgerät, DIM, CV, 12V 2,5-25W











IP20 **CE**

**Elektrische Daten**

Betriebsart	spannungskonstant	Eingangsspannung	220-240V AC/50-60Hz
Leistung	2,50-25,00 W	Leistungsfaktor	>0,95
Ausgangsspannung	12V DC	Anschlußmöglichkeit	Anschlussbox
Ausgangsstrom	200-2080 mA		

**Produkteigenschaften**

	Schutzklasse II		Überspannungsschutz
<b>SELV</b>	Schutzkleinspannung		Lampenbetriebsgerät 110
	Kurzschlußfest		Möbeleinbau geeignet
	Überlastschutz	<b>ErP</b>	Standby-Stromverbrauch < 0,5 W
	Übertemperaturschutz	<b>LVD</b>	Sicherheit nach EN 61347
	Sicherheitstrafo	<b>EMC</b>	Funkentstörung + Störfestigkeit nach EN 55015 + EN 61547
	dimmbar - Phasenanschnitt oder Phasenabschnitt	<b>EMC</b>	Netzstromoberwellen + Flicker nach EN 61000-3-2 + EN 61000-3-3

Schwarze Felder sind zutreffend / graue Felder sind nicht zutreffend

**Artikel Nr.: 862169**

Netzgerät, DIM, CV, 12V 2,5-25W

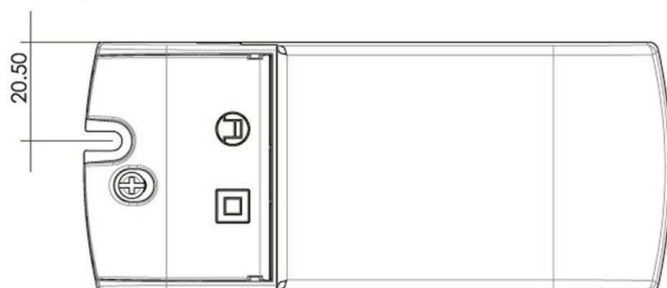
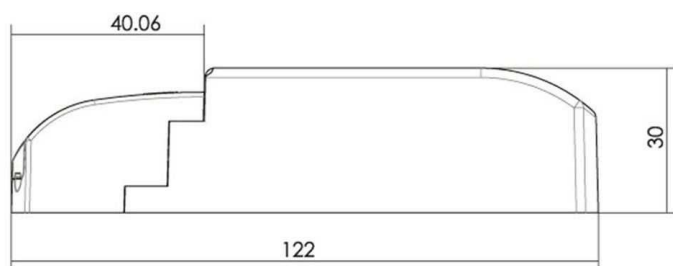
**Abmessungen und Gewicht****Grenzwerte**

Länge	122,00 mm	Betriebstemperatur	-20°C - +50°C
Breite	52,00 mm	Gehäusetemperatur	0 °C
Höhe	30,00 mm		
Durchmesser	0,00 mm		
Gewicht	100 g		

Article No.: 862169

Power supply unit, DIM, CV, 12V 2,5-25W











IP20 CE

**Electrical Characteristics**

Operating mode	constant voltage	Input voltage	220-240V AC/50-60Hz
Power	2,50-25,00 W	Power factor	>0,95
Output voltage	12V DC	Connection possibility	Connection box
Output current	200-2080 mA		

**Product features**

	Protection class II		Overvoltage protection
SELV	Low voltage protection		Lamp control gear 110
	Short circuit protection		Suitable for furniture installation
	Overload protection	ErP	Standby-power consumption < 0,5 W
	Overheating protection	LVD	Safety according to EN 61347
	Safety transformer	EMC	Interference suppression + immunity according to EN 55015 + EN 61547
	dimnable - leading edge or trailing edge	EMC	Mains harmonics + flicker according to EN 61000-3-2 + EN 61000-3-3

Black fields are applicable / gray fields are not applicable

**Article No.: 862169**

Power supply unit, DIM, CV, 12V 2,5-25W

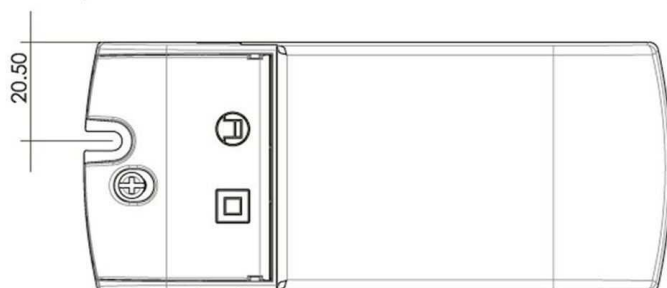
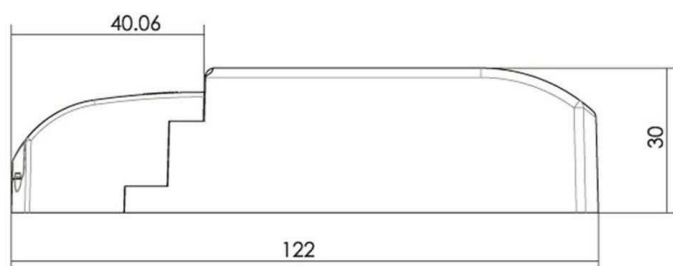
**Dimensions & Weight**

Length	122,00 mm
Width	52,00 mm
Height	30,00 mm
Diameter	0,00 mm
Product weight	100 g

**Absolute maximum ratings**

Operating temperature	-20°C - +50°C
Case temperature	0 °C